

2nd IF UNIT

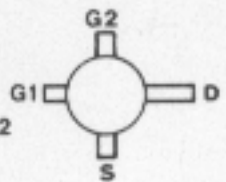

2nd LO UNIT

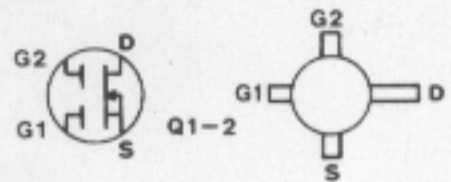
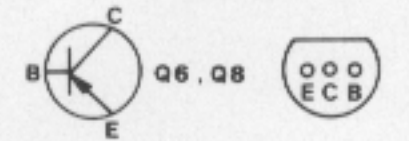
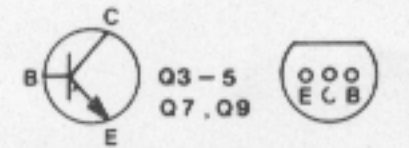
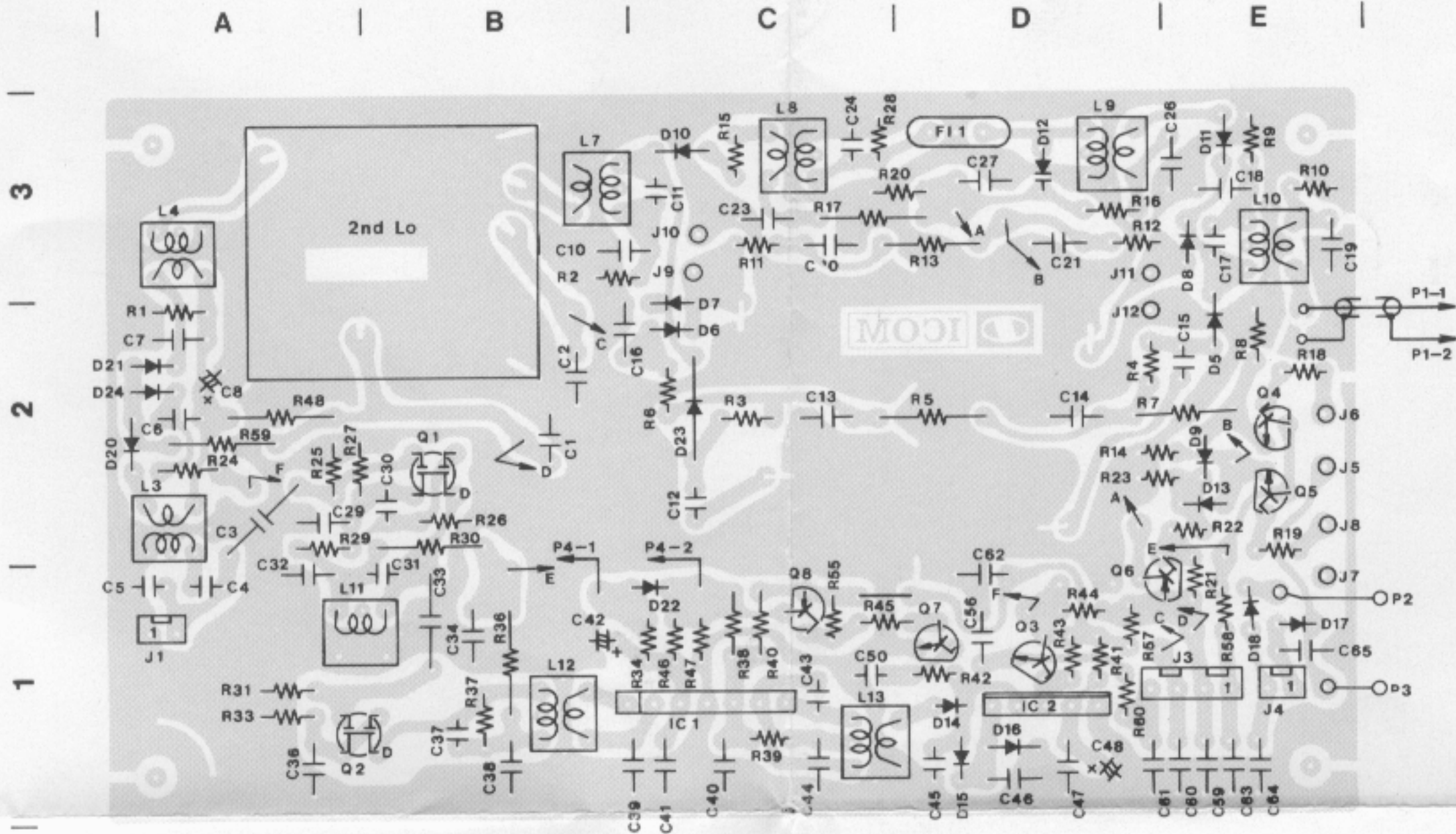
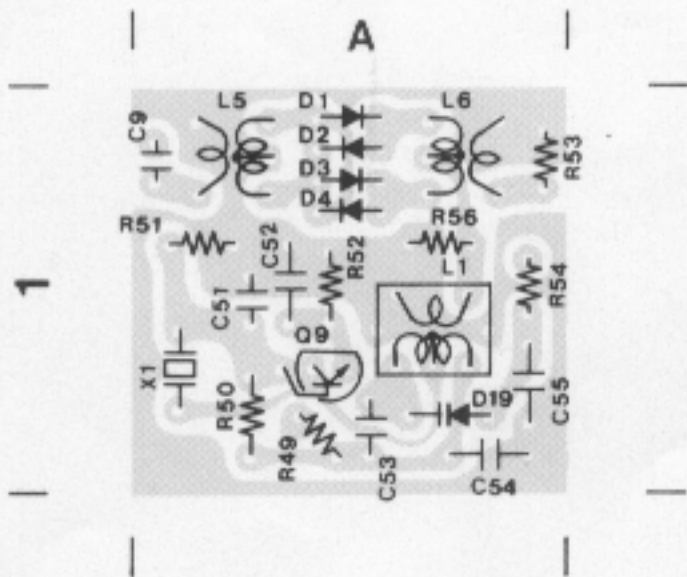

Q9



ACC UNIT

A

B

3

2

1

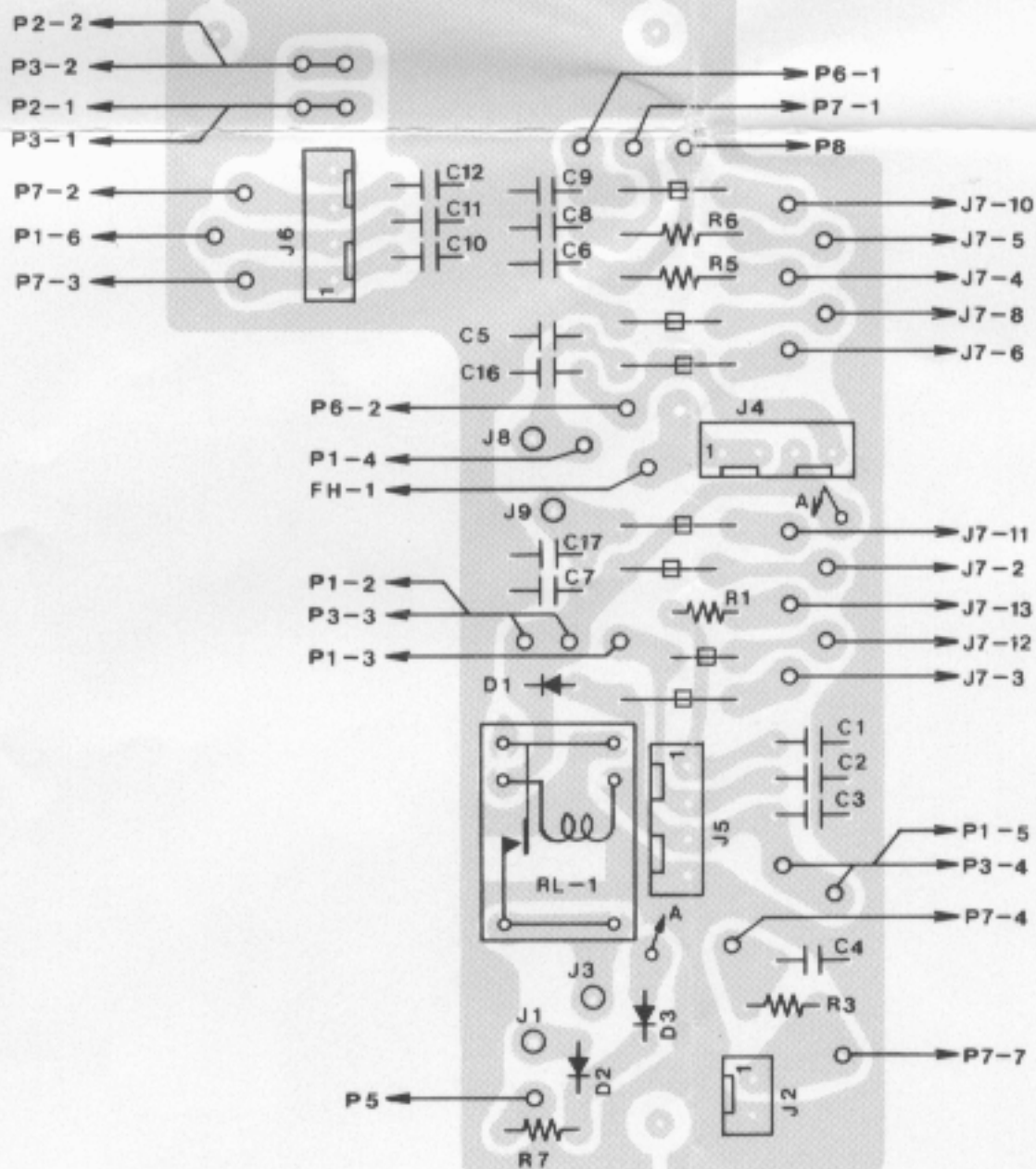

BPF UNIT

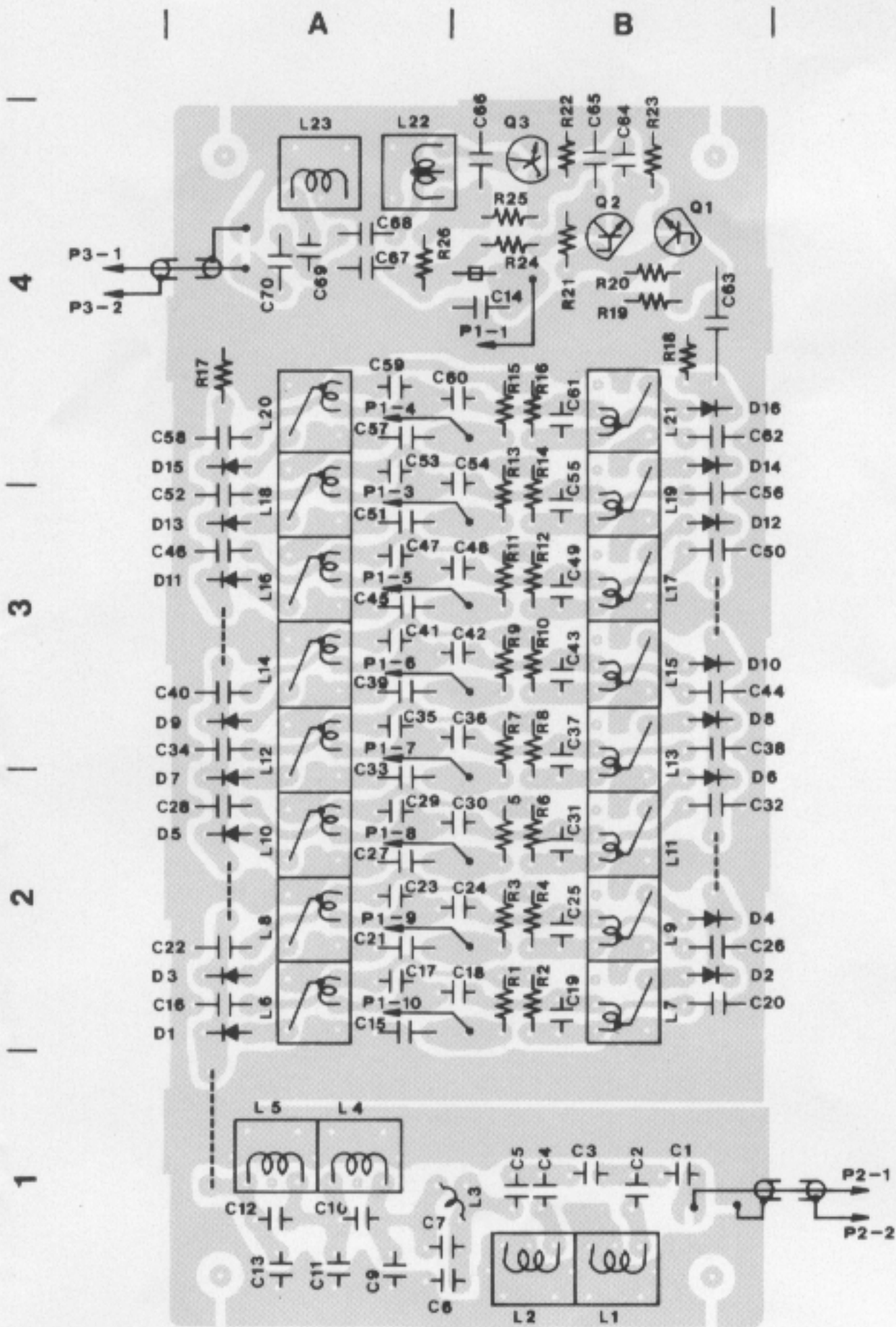

DETECTOR UNIT

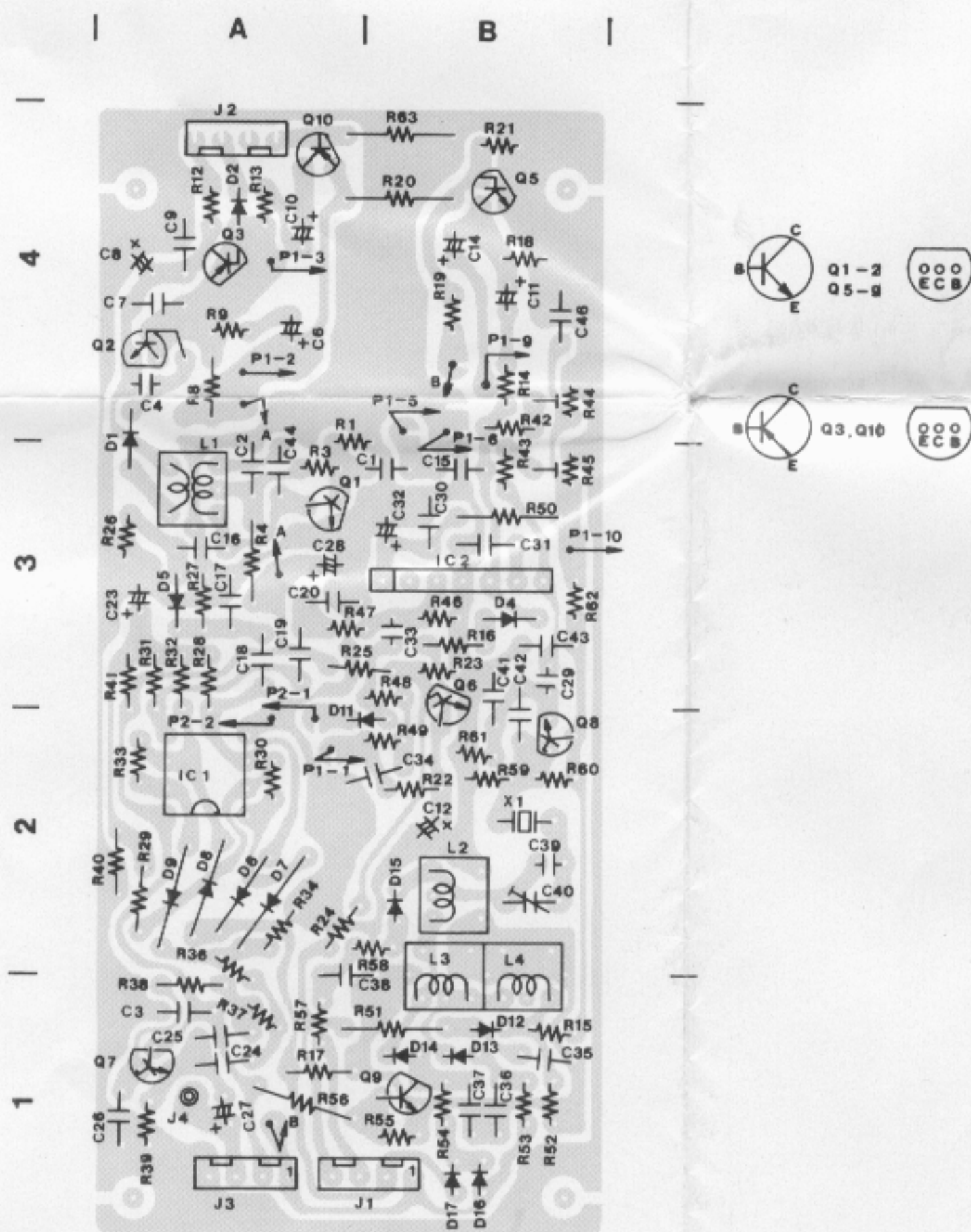

IC-730

EF UNIT

■ RIT BOARD

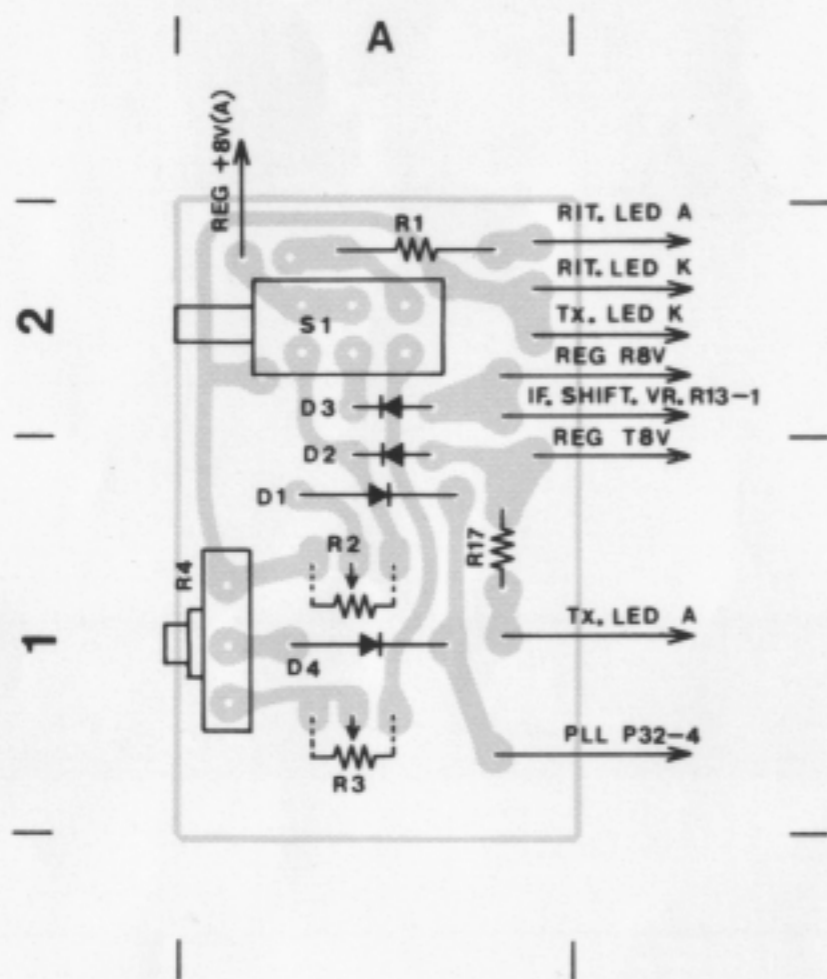

■ M SW BOARD

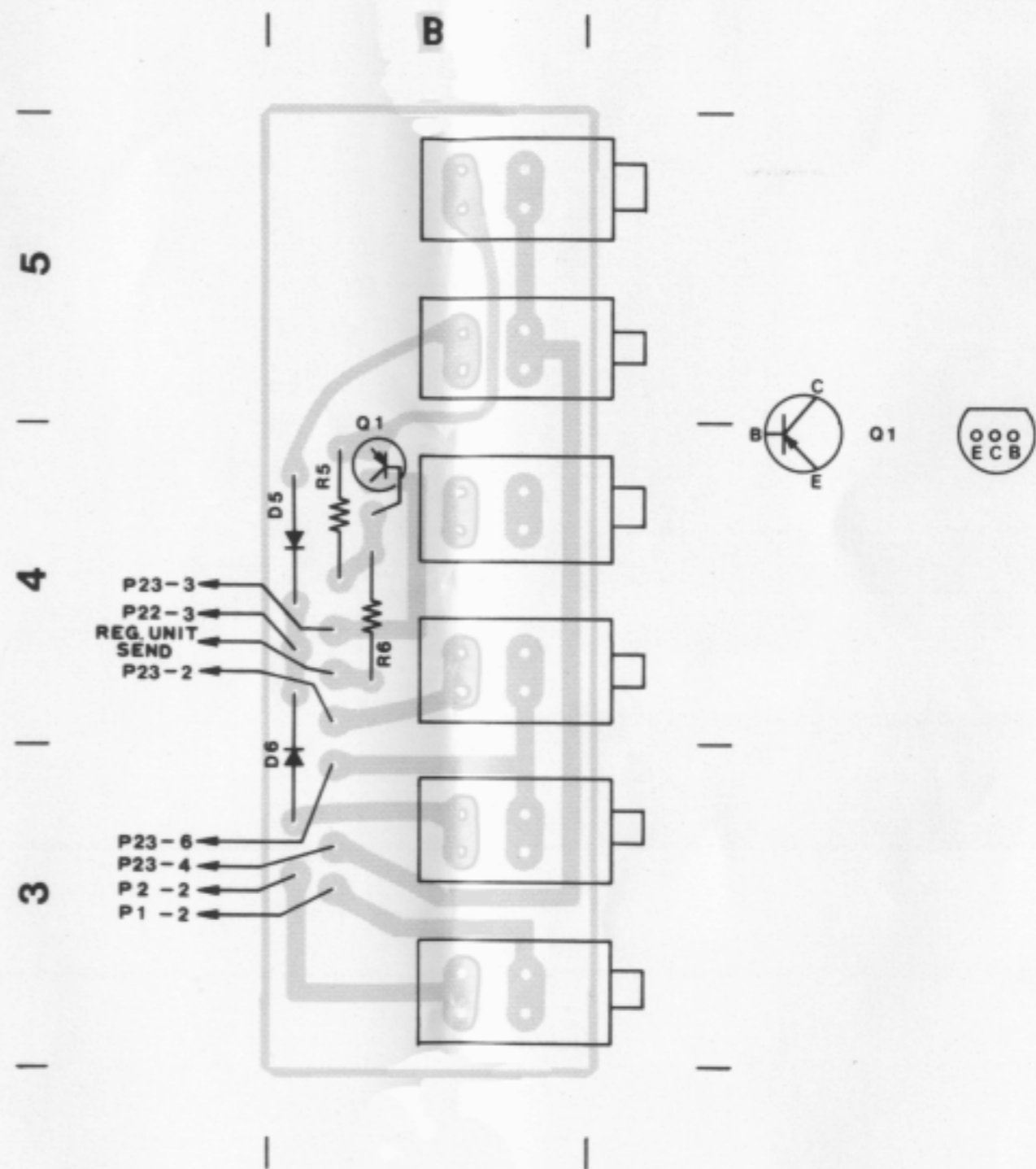

■ DISPLAY BOARD

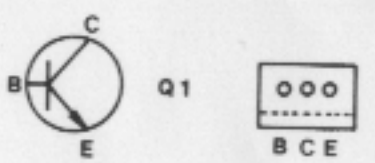
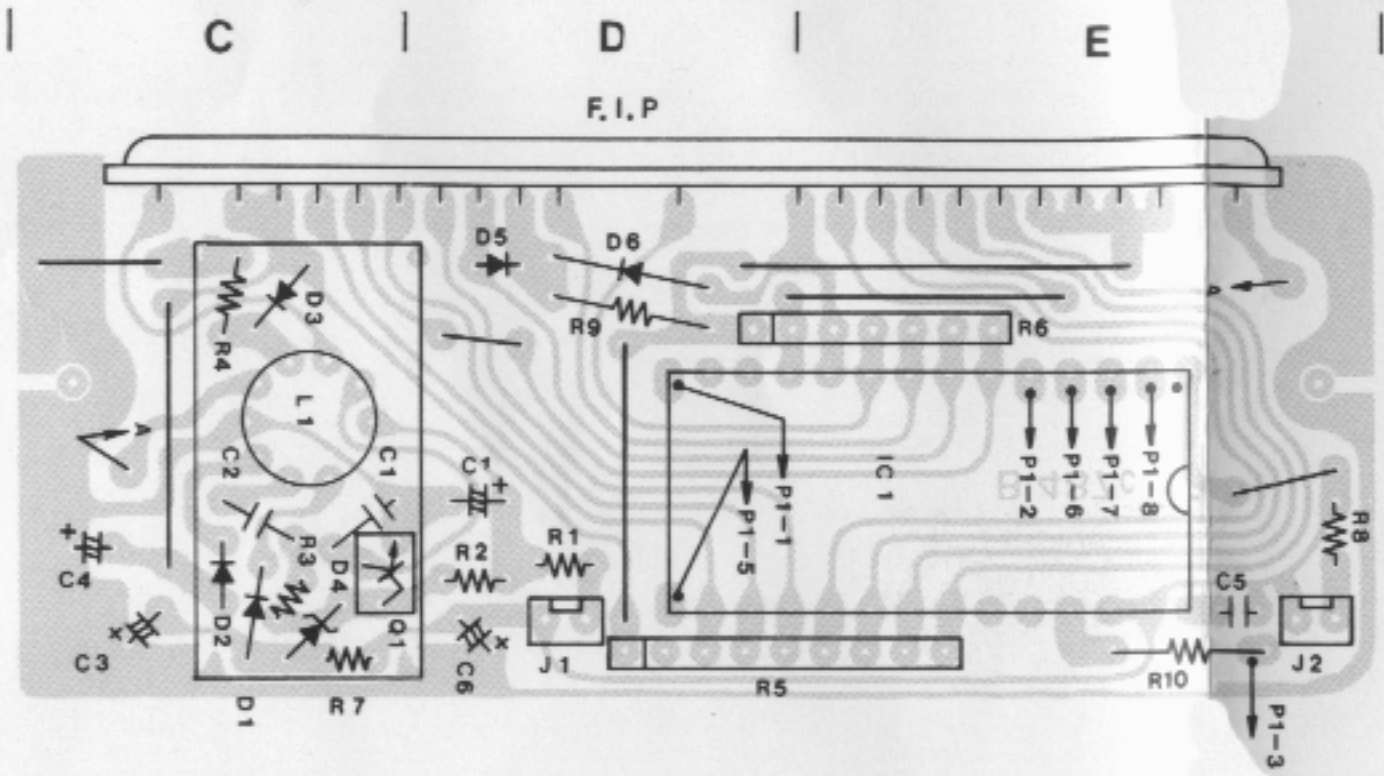

■ F SW BOARD

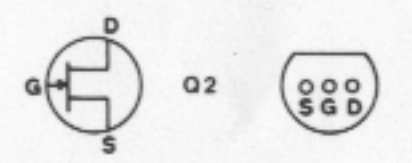
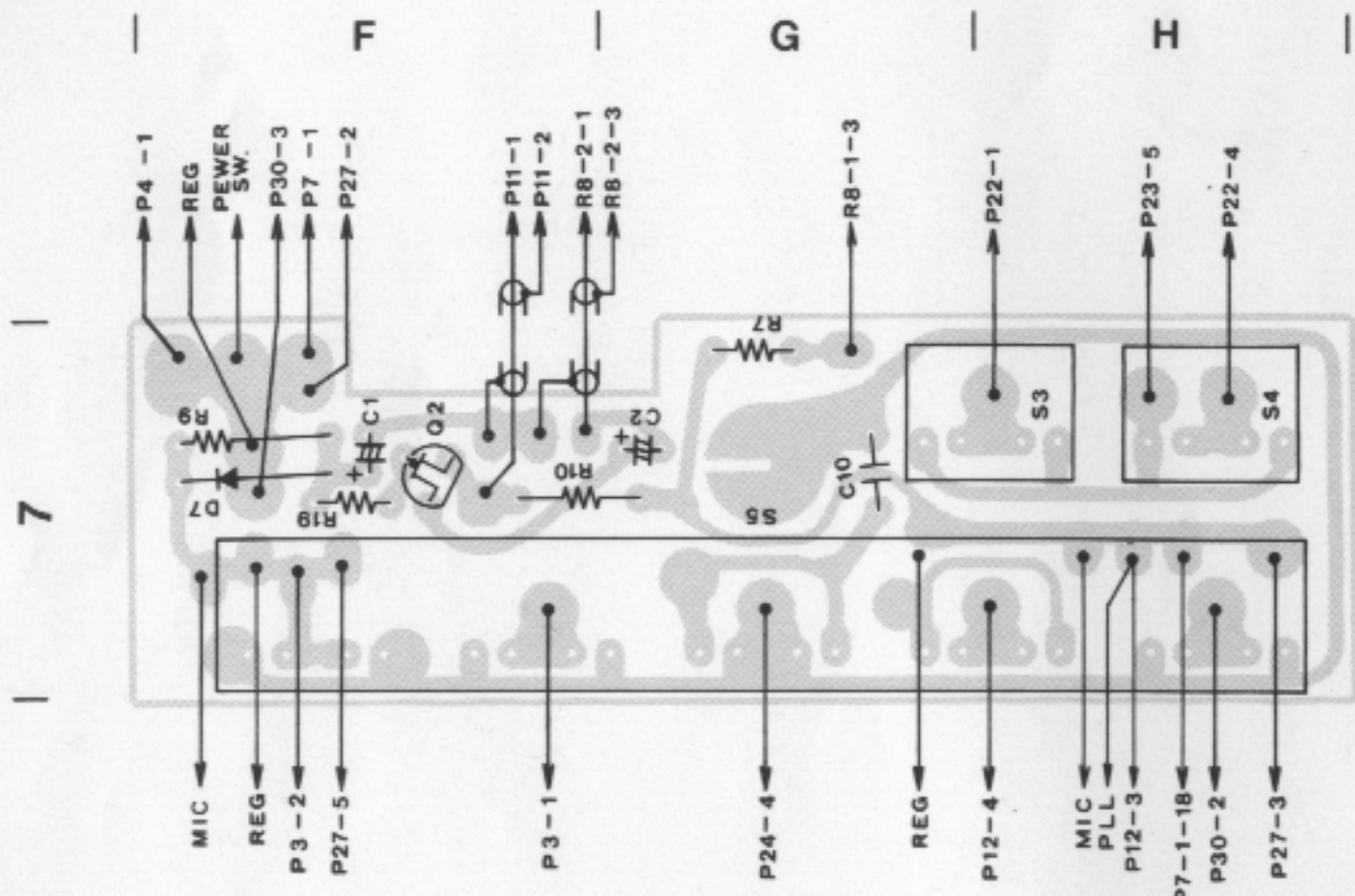

■ SENSOR BOARD

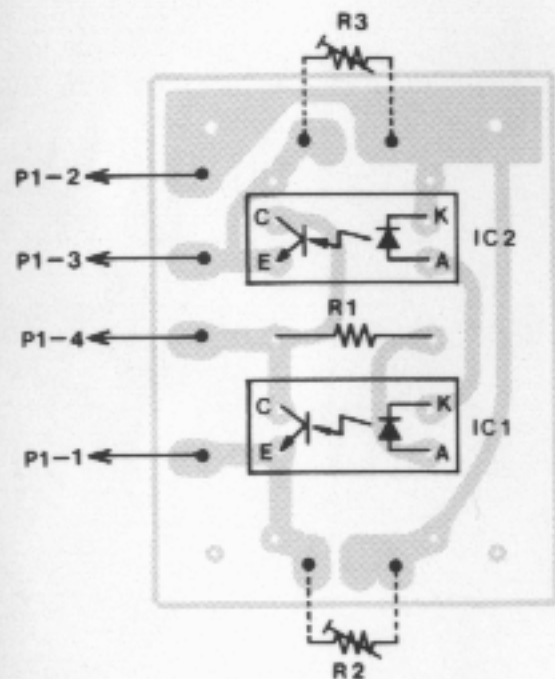

■ MIC BOARD

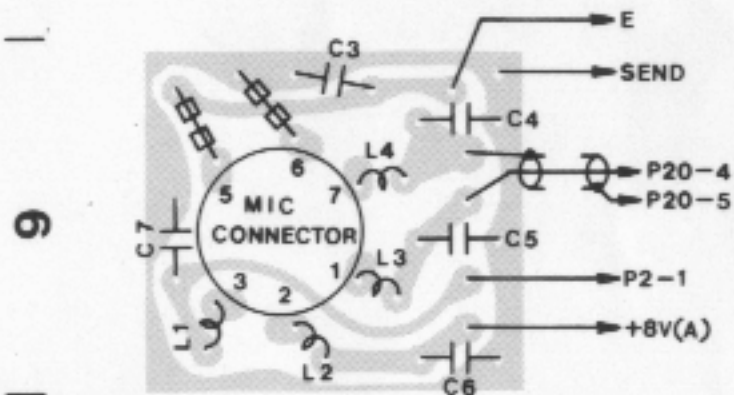

FILTER UNIT



LOGIC UNIT

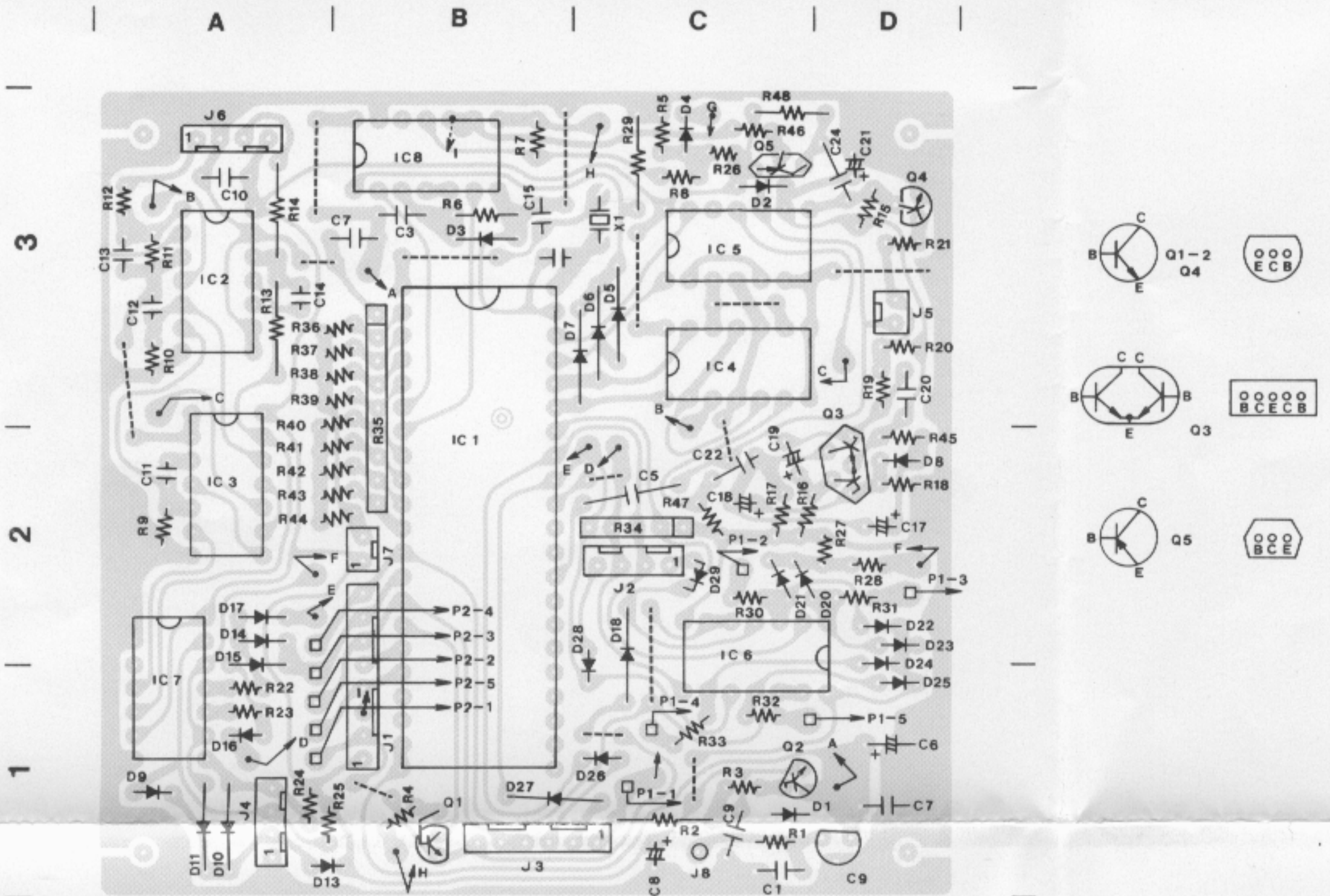

MAIN UNIT

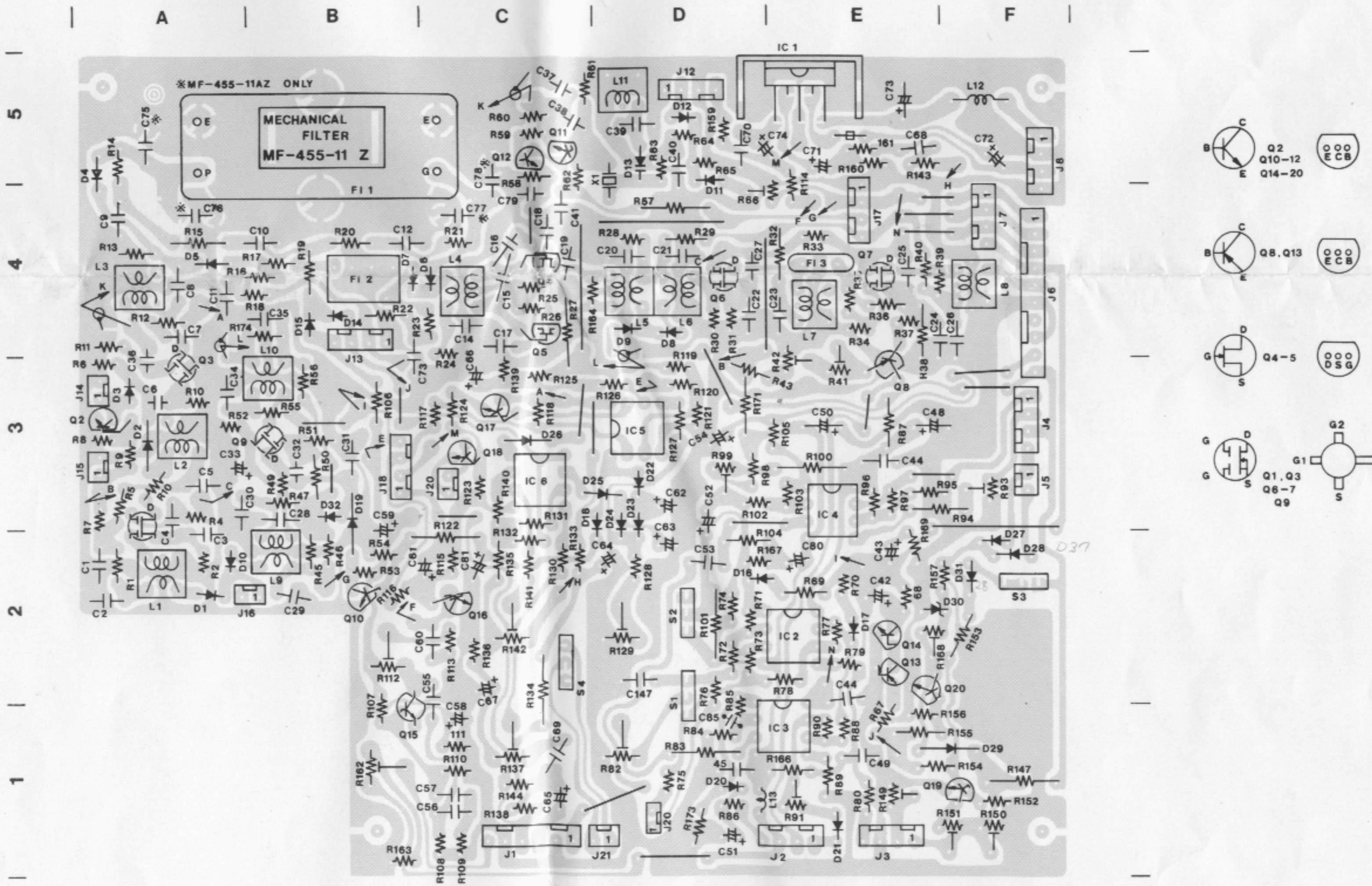

PA UNIT

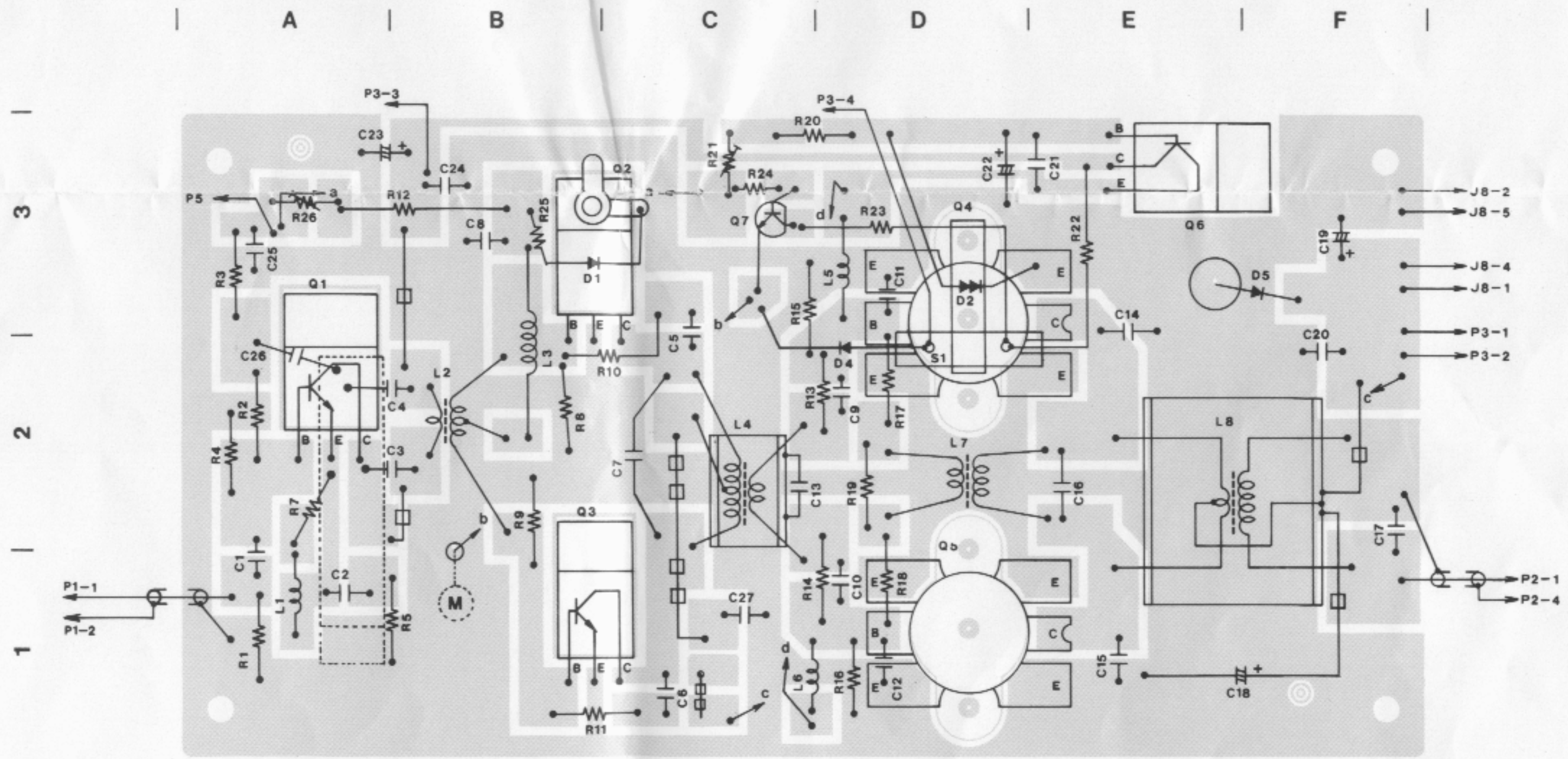

PLL UNIT

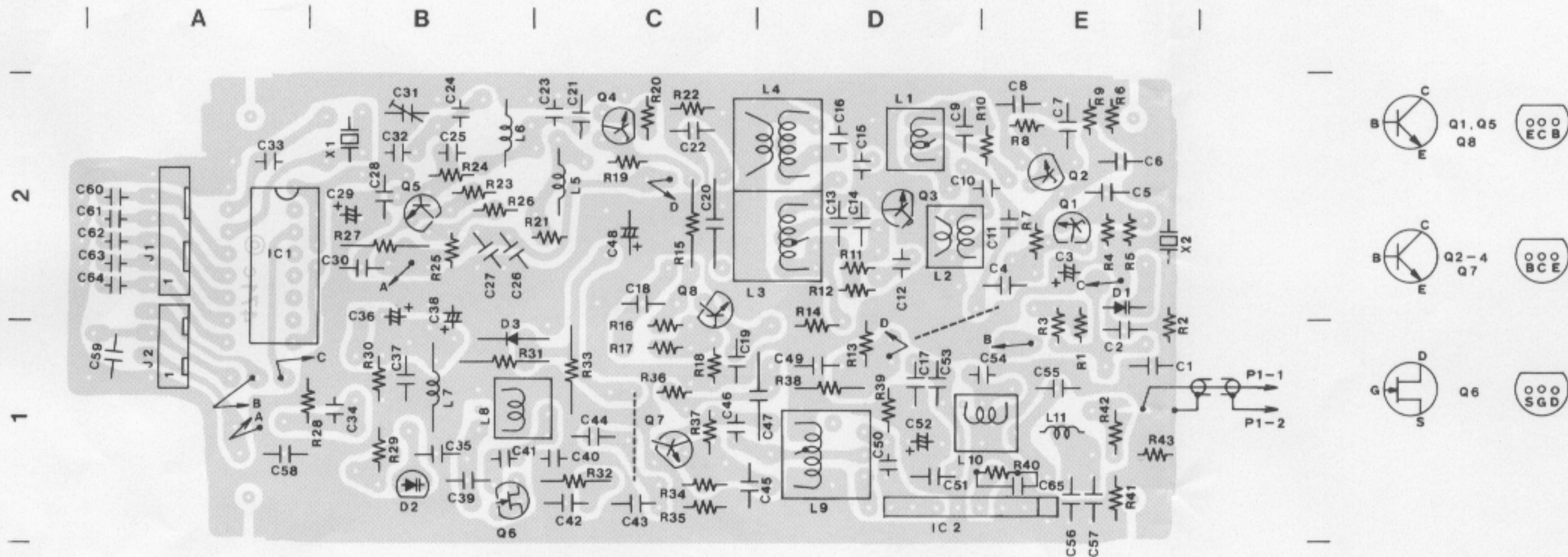

PREMIX UNIT

A

B

C

D

E

3

2

1

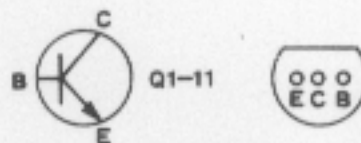
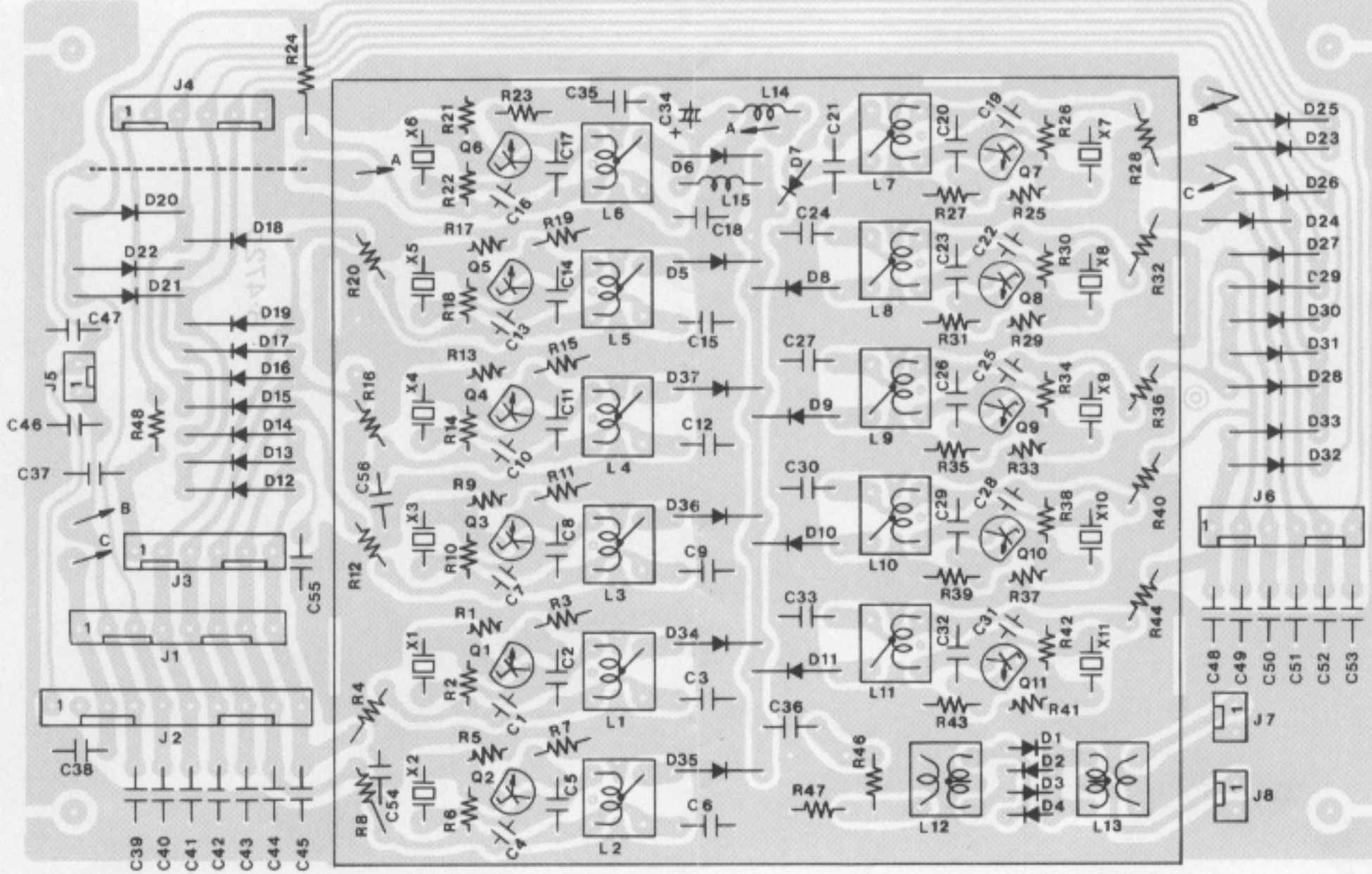

REGULATOR UNIT

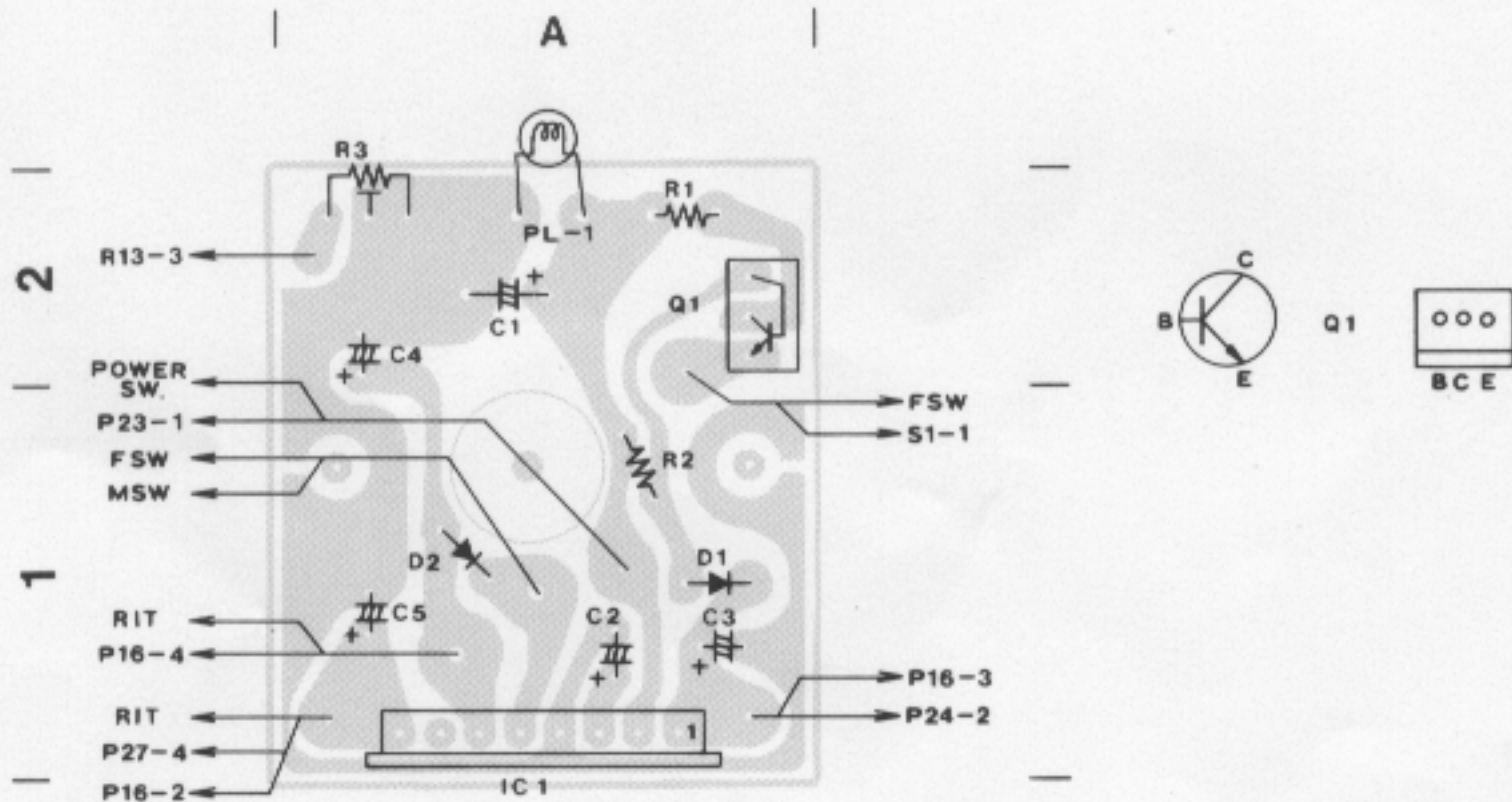

RF UNIT

